

Article number: 0102093

Description: Retaining ring J90 DIN472  
Spring steel

## Measures

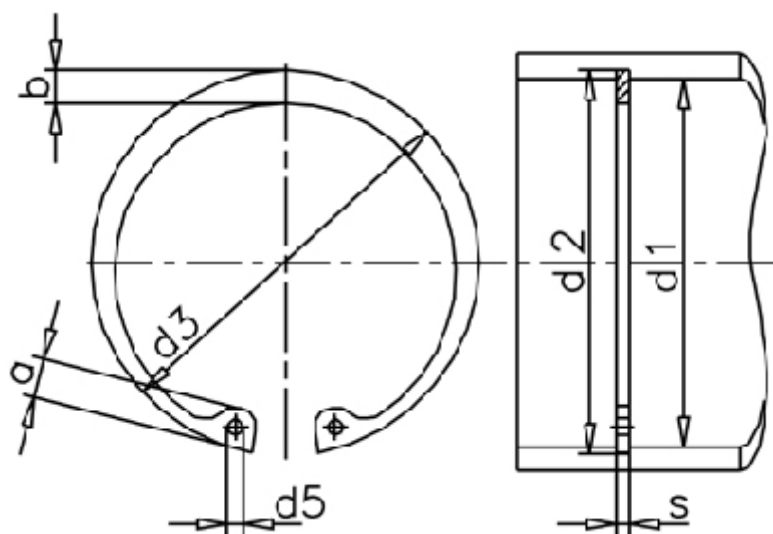

a max	= 8.6	FN kN	= 84.00	t	= 1.75
AN mm <sup>2</sup>	= 504.0	FRg kN	= 31.4	tol	= +0,35
b	= 7.6	FR kN	= 199.0	tol	= +1,30-0,54
d1	= 90	g	= 3.0	tol	= -0.08
d2	= 93.5	K kN-mm	= 364.0	Tong	= ZGJ-3
d3	= 95.50	m min	= 3.15	Weight kg/1000	= 33.00
d5 min	= 3.5	Nominal drive	= 5.3		
Description = J 90		s	= 3.00		